

TAU-170/25W

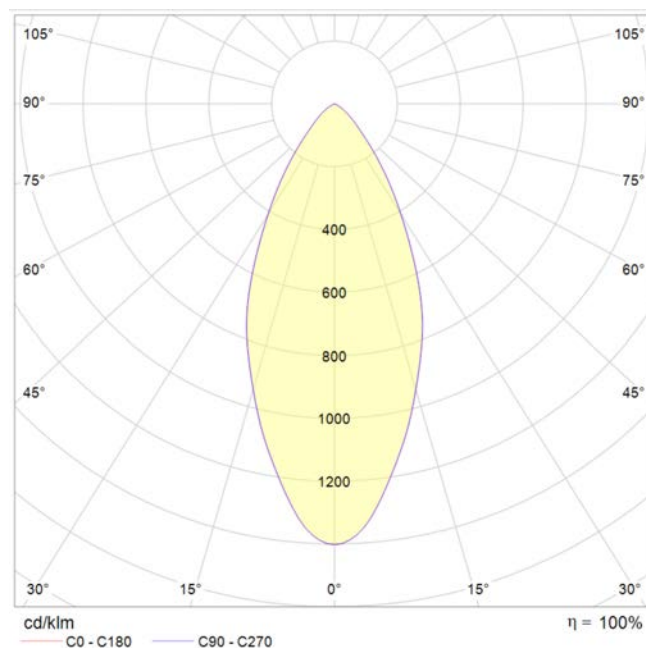
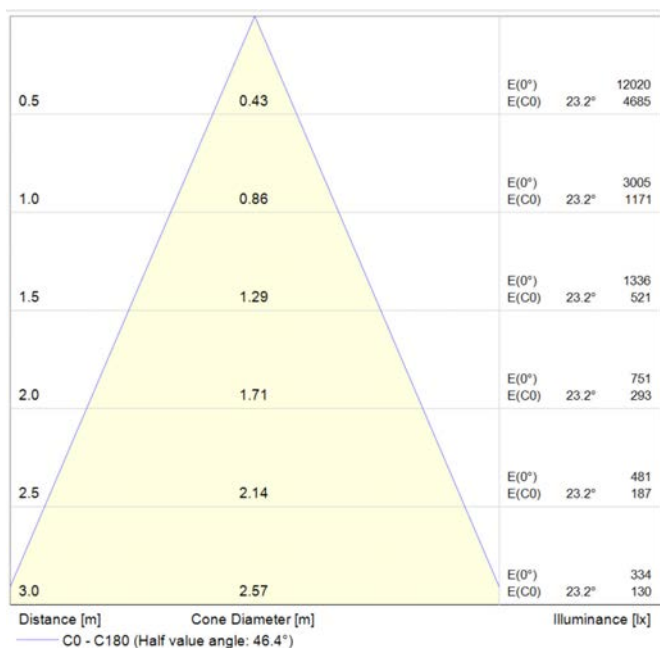
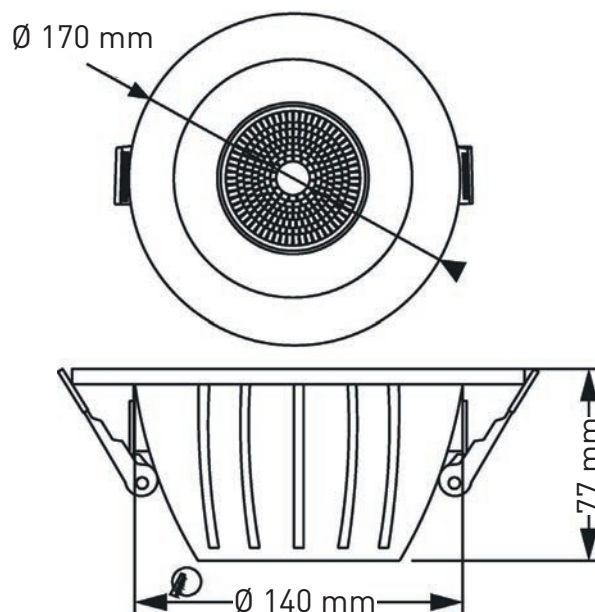

Koda:	T.17025
Napetostni vir:	230V - 50/60 Hz
Električna moč:	26,5W
Celotni svetlobni tok:	2270 lm
Svetlobni izkoristek:	86 lm/W
Fotobiloška zaščita:	RG1
Barvna temperatura:	3000K, 4000K, 5000K
Barvno odstopanje - MacAdam:	SDCM 3
UGR:	<19

Barvni index - CRI	>80, >90
Življenska doba:	L85B10 - 50.000 h (tq +25°C)
IK zaščita:	04
IP zaščita:	IP44 / IP20
Driver:	Tridonic - SELV. CLASS II - Pf 0,95
	Garancija 5 let
Svetlobni vir:	CREE LED 50.000 h
Barva:	Bela RAL 9016
Zatemnitev:	DALI, Tipka DIMM